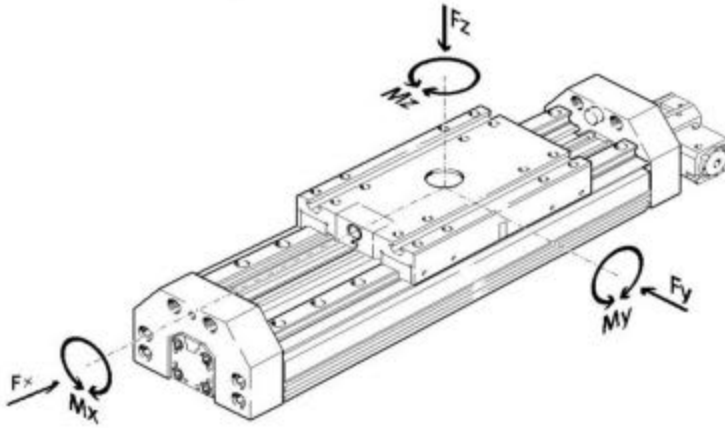
**Teknik Özellikler**

<b>Gövde</b>	:	Alüminyum (6063) Sigma Profil
<b>Maksimum Hız</b>	:	0,10 m/s
<b>Vidalı Mil Alternatifleri</b>	:	Ø 16-05 / Ø 16-10 / Ø 16-16
<b>Somun Alternatifleri</b>	:	Ø 16-05 / Ø 16-10 / Ø 16-16 Flanşlı
<b>Mil</b>	:	Ø 16 Krom Kaplı ( 0,2-0,33 µm ) indüksiyonlu
<b>Lineer Rulman</b>	:	16 UUOP
<b>Üst Plaka Ölçüleri</b>	:	130x130mm
<b>Tekrarlama Hassasiyeti</b>	:	L: 1000mm +-0,1mm
<b>Maksimum strok</b>	:	1500mm
<b>Opsiyonel Ekipmanlar</b>	:	Kaplin, Motor Bağlantı Flanşı
<b>Motor Seçenekleri</b>	:	Servo , step, asenkron motor

**Yük ve Moment Değerleri**

Yük			Moment		
Fx	Fy	Fz	Mx	My	Mz
6000 N	2000 N	7000 N	200 Nm	340 Nm	150 Nm