

DMX/DMX-A

Modular progressive divider valves

High quality and **high tolerance**
with **precision machines**

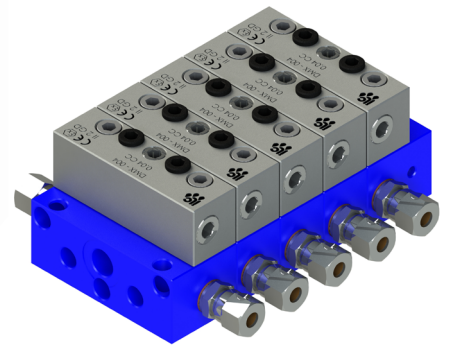
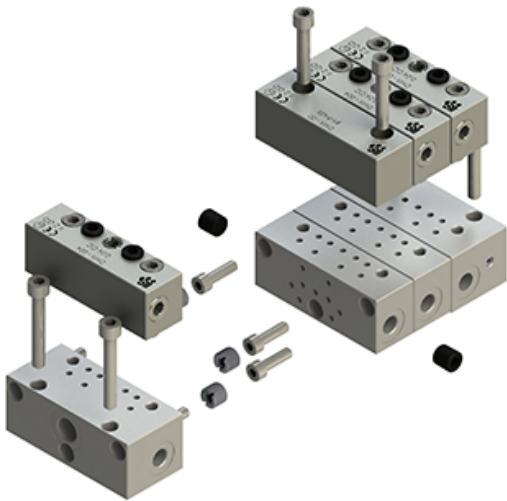

TABLE OF CONTENTS

DMX		Visual pin	14
Description	3	Inductive control	14
Technical data	4	Cycle control	14
Assembly and components	5	Group II Category 1D-1G/2G	15
		Group II Category 3G-3D	15
		Inductive control (ATEX)	15
Bases		Visual pin and By-pass	16
Metering bases	5	Bridge element	16
Ordering codes (Zi-Ni)	6	By-pass element	17
Single bases	6	Pressure pin indicator (with memory)	17
Assembly	6	Bridge element and sensors	17
Single bases	7	Connection fittings	18
Assembly	7	DIN 2353 Fittings Straight	18
Ordering codes (SS316L Steel)	7	DIN 2353 Fittings 90°	18
Junctions	8	PUSH-IN Fittings Straight	18
BANJO with grease nipple	8	PUSH-IN Fittings 90°	18
Inset filter	8	Check Valve	18
Inset filter 70 µ	8	Metering block assembly order	19
Valvole Shut-Off EV-2	9	Assembly ordering codes	19
Shut-Off Valves	9		
		DMX-A	
Metering valves		Air-oil modular progressive valves	20
Metering valves components	10	DMX-A	20
Assembly	10	Application fields	21
Replacement	10	Ordering informations	22
Components	10	Single bases	22
Outlet and dimensions	11	Connections	23
Outlets	11	Outlet fittings	23
Metering Valve	12	DMX element air consumption	23
With visual pin indicator	12	Valves and air consumption	23
With inductive sensor M8	12	Connections	24
With inductive sensor M12	12	Shut-off Valves	24
Ordering codes Zi-Ni	12	Metering block assembly order	25
Ordering codes SS316L	13	Assembly ordering codes	25
Metering Valve	13		
With visual pin indicator	13		
With inductive sensor M8	13		
With inductive sensor M12	13		

Features and general description

DMX is a progressive modular distributor. It measures out and divides lubricant thanks to piston movement.

This system is highly qualified to measure out oil and grease for one or more support groups.

Every piston is in line with the previous one and the next one. When a piston fails to work, as for an external obstruction, the whole system stops (this happens even when we place a plug on a unused outlet).

A single control element is enough to check the functioning of the whole distribution system.

The DMX modular system consists of two main parts: Base (divided into initial base, intermediate base and final base) and the Metering Elements (available in different outputs).

The system can be easily extended and its modularity allows a low cost component replacement.

The assembled base can be installed and connected without Modular Metering elements to make easier the Tube tracking process. Metering elements can be installed later.

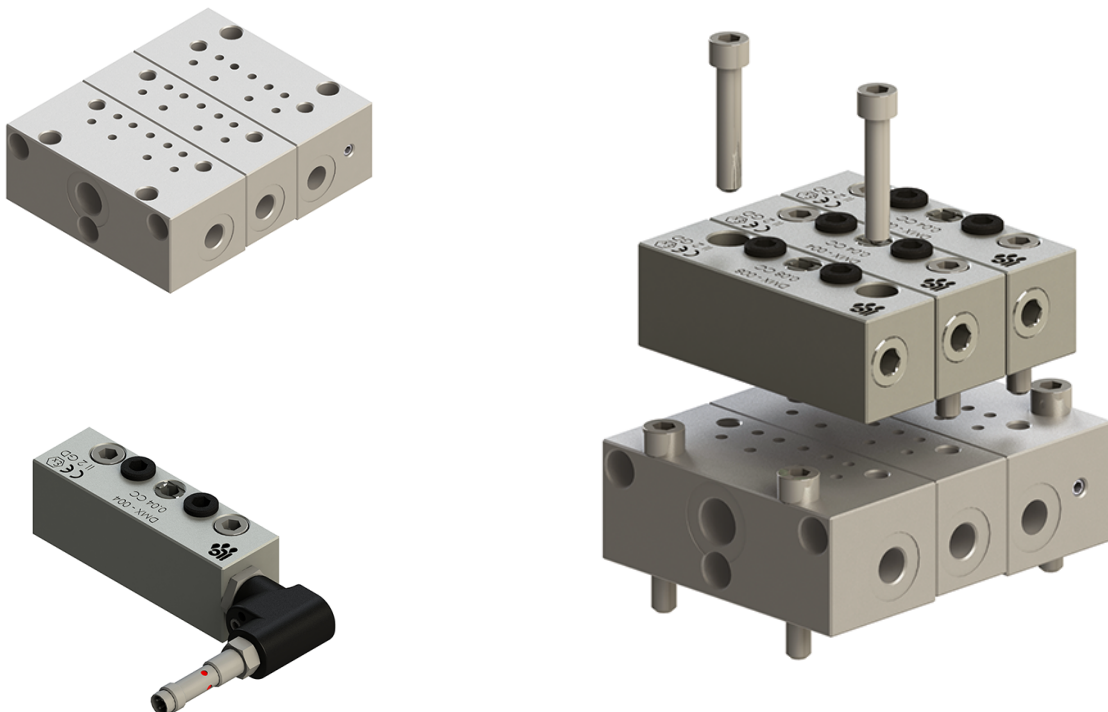

Working pressure	Min 15 Bar Max 400 Bar
Lubricants [at minimum working temperature]	Mineral oil with minimum viscosity of 15 cSt at fluid working temperature. Grease consistency NLGI-2 Max
Working temperature	From -40 °C to + 120 °C
Output for outlet (mm ³)	Available piston size 40/ 80 / 160 / 250 / 400 / 500 / 650
Inlet	1/4" BSP
Outlet	1/8" BSP
Number of elements	From 3 to 20
Cycles	Max 500
Gasket	"O"-ring Viton 90 sh
Parts protective coating	Zinc-Nickel 800 hour salt spray tested
Marking	ATEX II GD - CE
Material	Steel, Zn-Ni plated (free of Cr-V) or SS316L
Metering element	Supplied with screw
Element: initial base	Supplied with screw and "O"-Ring
Element: intermediate base	Supplied with screw, adapter screw and "O"-Ring
Element: final base	Supplied with screw
Metering valves interchangeability	Graco MSP - Bijur serie M2500G - Dropsa serie SMX
Bridge element	Supplied with adapter screw. Screw replace junctions bridge in order to convey the output of one or more output into the next one.
By-pass element	Supplied with screw . They are used as a reserve for additional points or for metering valves replacement in case of output reduction
Monitoring element	Visual or inductive
Air purge	2 valves included in the final base
Torque tightening (base)	15 Nm
Torque tightening (elements)	15 Nm

Assembly and components

The metering base is made of a serie of at least three elements: one initial base, an intermediate one and a final one.

Thanks to a flexible and easy assembling process, the intermediate bases can be increased later to a maximum of 18. We can always add modules using the fixing bushes supplied with the assembly.

The system can operate ad high pressures without lubricant loss between elements.

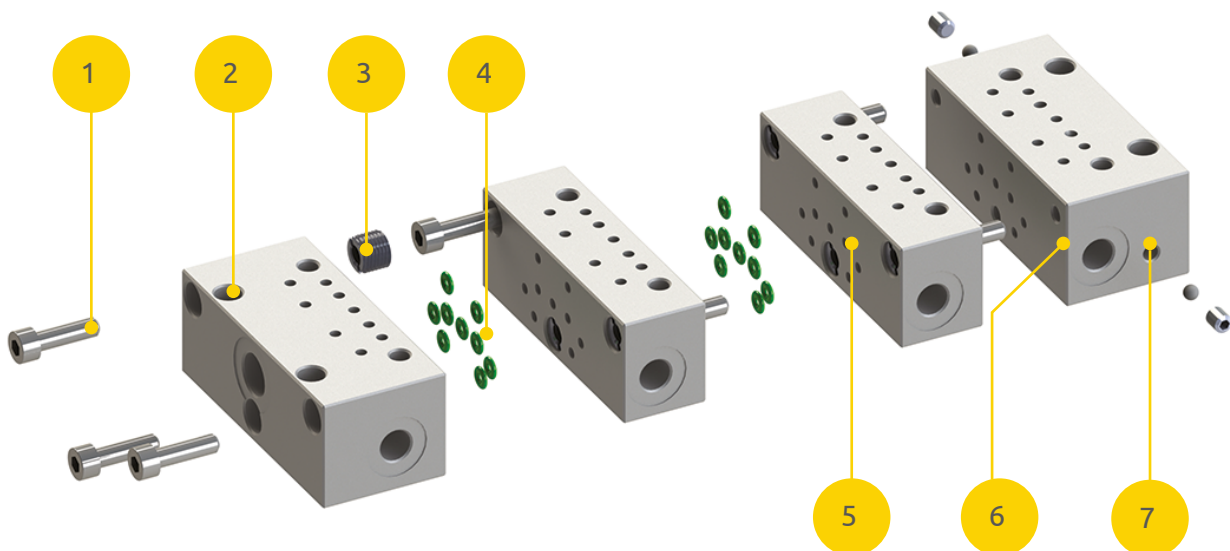

- | | | | |
|---|-----------------------|---|-------------------|
| 1 | Base assembling screw | 5 | Intermediate base |
| 2 | Initial base | 6 | Purge air valve |
| 3 | Fixing bushes | 7 | Final base |
| 4 | "O"-ring | | |

Single bases

3.DMX.A/B/C

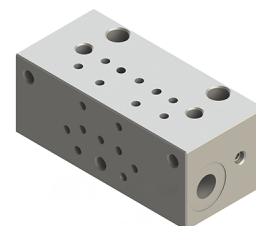
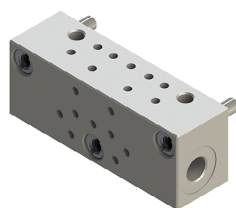
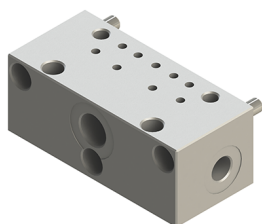

Code	3.DMX.A	Code	3.DMX.B	Code	3.DMX.C
Descrizione	Initial base	Descrizione	Intermediate base	Descrizione	Final base

Assembly

3.DMX.03...20

Code	Assembled bases
3.DMX.03	3
3.DMX.04	4
3.DMX.05	5
3.DMX.06	6
3.DMX.07	7
3.DMX.08	8
3.DMX.09	9
3.DMX.10	10
3.DMX.11	11
3.DMX.12	12
3.DMX.13	13
3.DMX.14	14
3.DMX.15	15
3.DMX.16	16
3.DMX.17	17
3.DMX.18	18
3.DMX.19	19
3.DMX.20	20

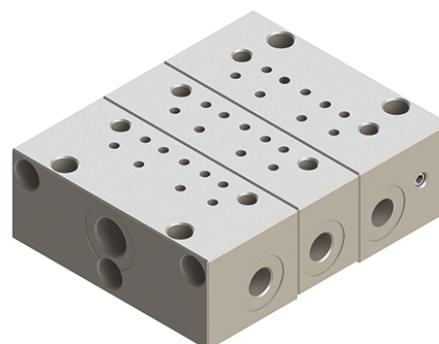

3.DMX.03

Single bases

3.DMX.A/B/C

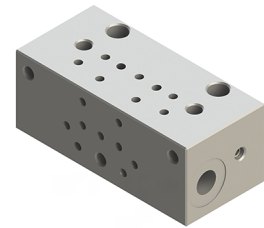
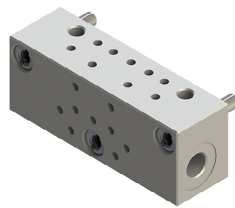
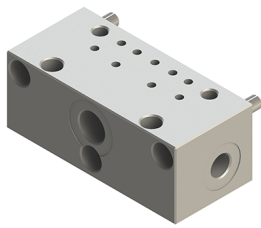

Code	3.DXX.A	Code	3.DXX.B	Code	3.DXX.C
Descrizione	Initial base	Descrizione	Intermediate base	Descrizione	Final base

Assembly

3.DMX.03...20

Code	Assembled bases
3.DXX.03	3
3.DXX.04	4
3.DXX.05	5
3.DXX.06	6
3.DXX.07	7
3.DXX.08	8
3.DXX.09	9
3.DXX.10	10
3.DXX.11	11
3.DXX.12	12
3.DXX.13	13
3.DXX.14	14
3.DXX.15	15
3.DXX.16	16
3.DXX.17	17
3.DXX.18	18
3.DXX.19	19
3.DXX.20	20

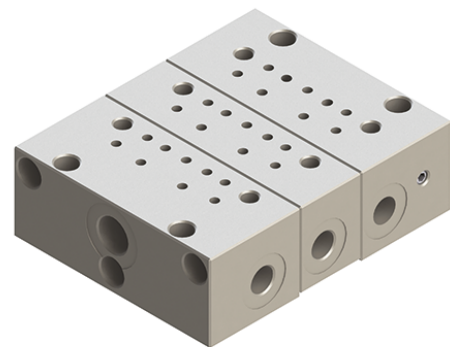

3.DXX.03

BANJO with grease nipple

03.355.5/ 03.355.7

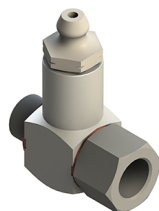

Banjo junctions are placed on a progressive distributor inset. Their job is to let us use a manual or hidraulic pump when the main pump does not work.

Code	Thread
03.355.5	1/4 BSP (inlet)
03.355.7	1/8 BSP (outlet)

Inset filter

07.261.1/07.261.3

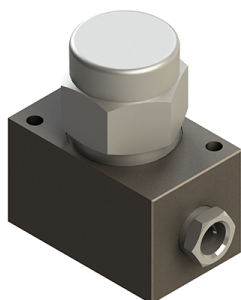

These strainer prevent the lubricant lines from being obstructed by impurities.

Supply joints included.
Filtration rate **150 μ**
Plug **1/4" BSP (F)**

Codice	Grado di filtrazione
07.261.1	300 μ
07.260.3	125 μ

Inset filter 70 μ

07.270.5

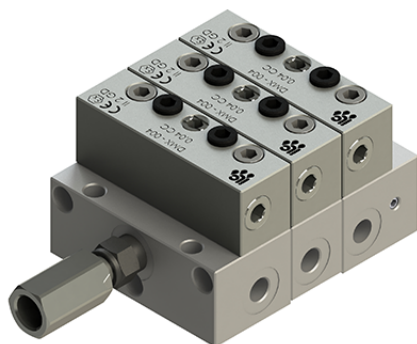

These strainer prevent the lurbricant lines from being obstructed by impurities.

Filtration rate **70 μ**
Plug **1/4" BSP (F)**

ORDERING CODE 07.270.5

Valvole Shut-Off EV-2

A70.093688/.115/.230

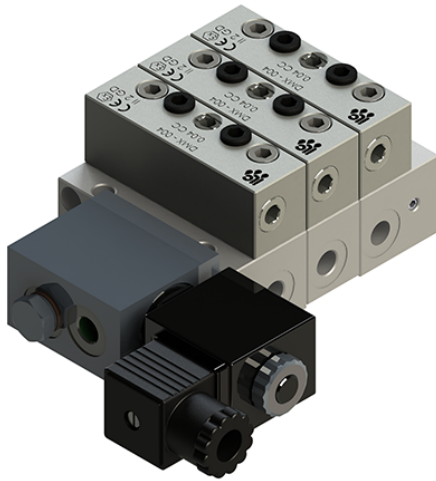

SHUT OFF valves EV-2 are made of a special "NC" 2-ways solenoid valve and of a modular base that can be directly assembled on the DPL inlet.

EV-2 valve is the essential element in order to transform a standard progressive system into a **sectioned system**.

Ordering codes

Code	Voltage
A70.093688	24 V DC
A70.093688.115	115 V AC
A70.093688.230	230 V AC

Technical data

Pressure	Max 300 Bar
Lubricant	Olii viscosità min 32 cSt Grasso max NLGI-1
Temperature	Da -20 °C a +80 °C
Voltage	24 V DC, 115 - 230 V AC 50/60 Hz.
Power	35 W (DC) 8 VA (AC)
Protection	IP54
Inlet	1/4" BSP

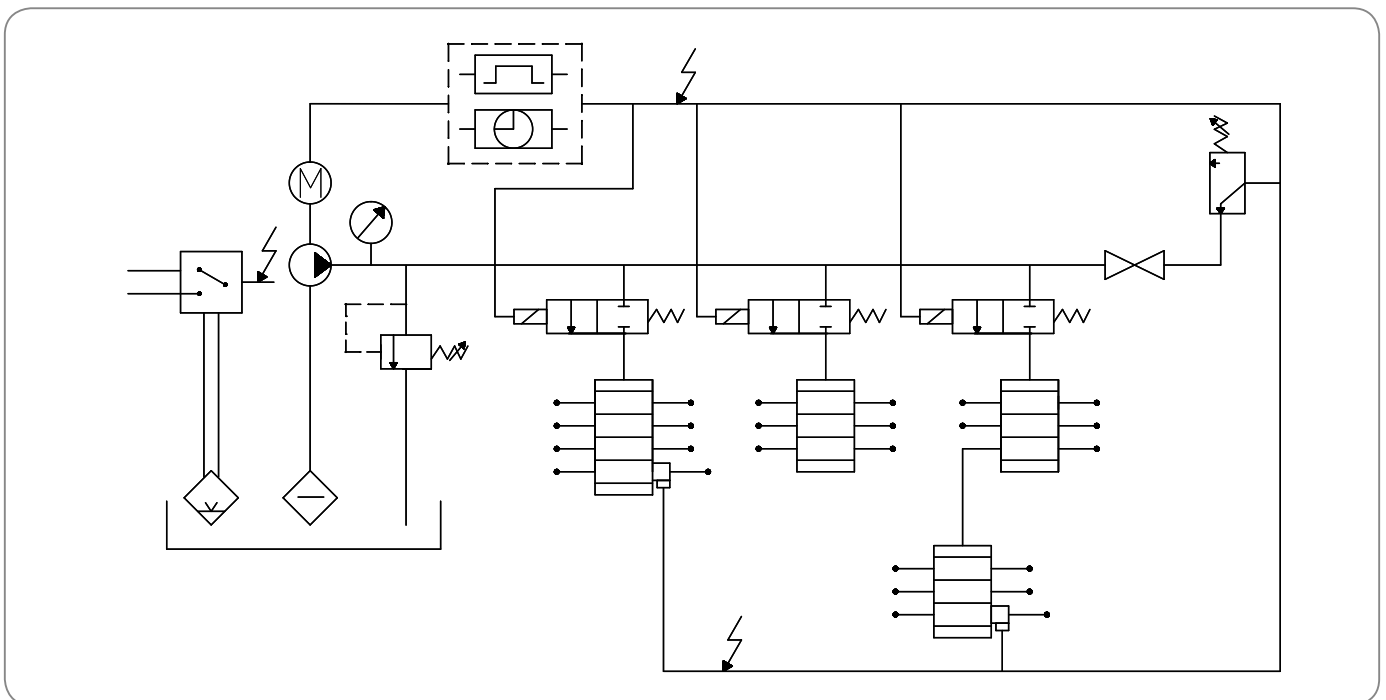

Metering valves components

The minimum number of metering valves in an assembled block is 3 and the maximum is 20.

The installation on the base is made using the two fixing screws TEC-UNI-5931 UNF 1/4 "x 1" 1/4 supplied with the metering valve.

The number of required metering elements, as long as their output and the presence of a moni-

toring control sensor, are mandatory in order to choose the right model.

It 's always possible to replace a valve with a different model without disconnecting the tubelines or open the base.

Assembly

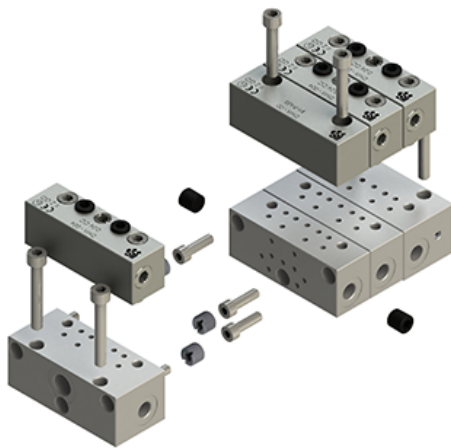

Assembling dosing elements is extremely simple.

Place it on its own base. Insert fixing screws and tighten them using a maximum 12 nm force.

During the operation pay attention to "O"-ring on the support base side.

Replacement

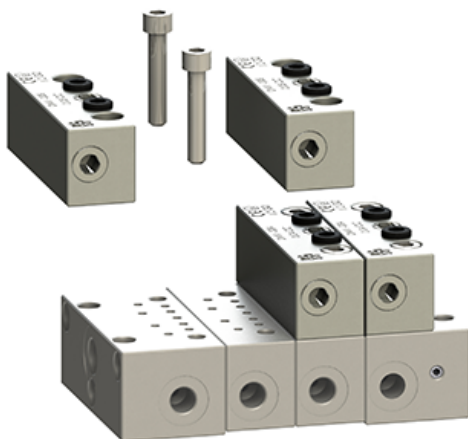

The same operation is required to replace a valve of insertion of a by-pass element.

Remove the fixing screws and the element itself. Install the new element as in the image aside.

Outlets

Metering elements are supplied with a set-up for one or two separate outputs.

It is always possible to modify this condition (from one to two and viceversa) turning the adapter screw between the vertical outputs as explained in the image below.

It is possible to sum the two output of the same element.

Remove the grub screw (code A51.087096 1/8" K) and the ring (Code A53.114116) replacing it with the grub screw (code A92.087058 1/8" K) as shown in the image below.

When the two outlet are connected remember to shut the unused one using the grub screw (code A92.087058 1/8" BSP CIL).

BE CAREFUL!
Always shut a no-longer-required outlet as shown in the image below. Else you would occur in system block and a valve alarm.

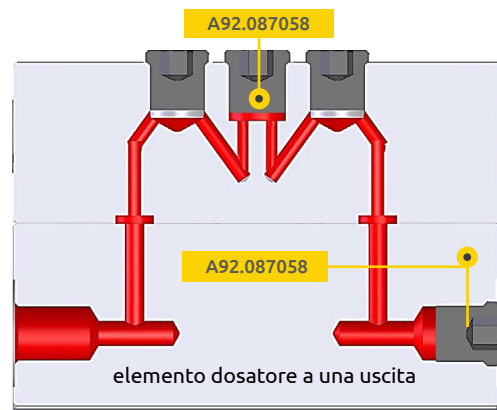
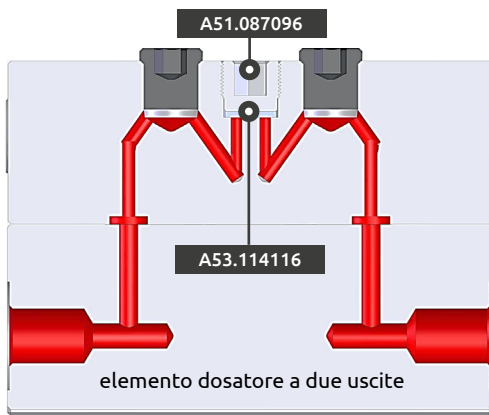

Assembly block dimensions

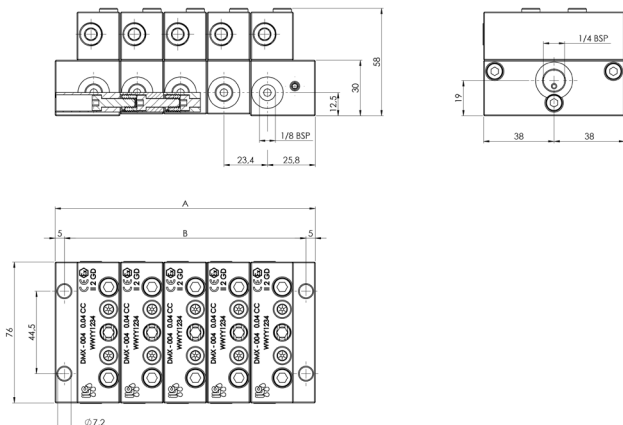

Base N°	B [mm]	A [mm]	Base N°	B [mm]	A [mm]
3	83.20	93.00	12	293.90	303.70
4	106.60	116.40	13	317.30	327.10
5	130.00	139.80	14	340.70	350.50
6	153.40	163.20	15	364.20	374.00
7	176.80	186.60	16	387.60	397.40
8	200.20	210.00	17	411.00	420.80
9	223.60	233.40	18	434.40	444.20
10	247.00	256.80	19	457.80	467.60
11	270.40	280.20	20	481.20	491.00

Metering Valve



double outlet

Code	Output
3.DMX.004.D.1N	40 mm ³ /cycle
3.DMX.008.D.1N	80 mm ³ /cycle
3.DMX.016.D.1N	160 mm ³ /cycle
3.DMX.025.D.1N	250 mm ³ /cycle
3.DMX.040.D.1N	400 mm ³ /cycle
3.DMX.050.D.1N	500 mm ³ /cycle
3.DMX.065.D.1N	650 mm ³ /cycle

single outlet

Code	Output
3.DMX.004.S.1N	80 mm ³ /cycle
3.DMX.008.S.1N	160 mm ³ /cycle
3.DMX.016.S.1N	320 mm ³ /cycle
3.DMX.025.S.1N	500 mm ³ /cycle
3.DMX.040.S.1N	800 mm ³ /cycle
3.DMX.050.S.1N	1000 mm ³ /cycle
3.DMX.065.S.1N	1300 mm ³ /cycle

With visual pin indicator



double outlet

Code	Output
3.DMX.008.D.2V	80 mm ³ /cycle
3.DMX.016.D.2V	160 mm ³ /cycle
3.DMX.025.D.2V	250 mm ³ /cycle
3.DMX.040.D.2V	400 mm ³ /cycle
3.DMX.050.D.2V	500 mm ³ /cycle
3.DMX.065.D.2V	650 mm ³ /cycle

single outlet

Code	Output
3.DMX.008.S.2V	160 mm ³ /cycle
3.DMX.016.S.2V	320 mm ³ /cycle
3.DMX.025.S.2V	500 mm ³ /cycle
3.DMX.040.S.2V	800 mm ³ /cycle
3.DMX.050.S.2V	1000 mm ³ /cycle
3.DMX.065.S.2V	1300 mm ³ /cycle

With inductive sensor M8



double outlet

Code	Output
3.DMX.008.D.3I.8	80 mm ³ /cycle
3.DMX.016.D.3I.8	160 mm ³ /cycle
3.DMX.025.D.3I.8	250 mm ³ /cycle
3.DMX.040.D.3I.8	400 mm ³ /cycle
3.DMX.050.D.3I.8	500 mm ³ /cycle
3.DMX.065.D.3I.8	650 mm ³ /cycle

single outlet

Code	Output
3.DMX.008.S.3I.8	160 mm ³ /cycle
3.DMX.016.S.3I.8	320 mm ³ /cycle
3.DMX.025.S.3I.8	500 mm ³ /cycle
3.DMX.040.S.3I.8	800 mm ³ /cycle
3.DMX.050.S.3I.8	1000 mm ³ /cycle
3.DMX.065.S.3I.8	1300 mm ³ /cycle

With inductive sensor M12



double outlet

Code	Output
3.DMX.008.D.3I.12	80 mm ³ /cycle
3.DMX.016.D.3I.12	160 mm ³ /cycle
3.DMX.025.D.3I.12	250 mm ³ /cycle
3.DMX.040.D.3I.12	400 mm ³ /cycle
3.DMX.050.D.3I.12	500 mm ³ /cycle
3.DMX.065.D.3I.12	650 mm ³ /cycle

single outlet

Code	Output
3.DMX.008.S.3I.12	160 mm ³ /cycle
3.DMX.016.S.3I.12	320 mm ³ /cycle
3.DMX.025.S.3I.12	500 mm ³ /cycle
3.DMX.040.S.3I.12	800 mm ³ /cycle
3.DMX.050.S.3I.12	1000 mm ³ /cycle
3.DMX.065.S.3I.12	1300 mm ³ /cycle

Metering Valve



double outlet

single outlet

Code	Output	Code	Output
3.DXX.004.D.1N	40 mm ³ /cycle	3.DXX.004.S.1N	80 mm ³ /cycle
3.DXX.008.D.1N	80 mm ³ /cycle	3.DXX.008.S.1N	160 mm ³ /cycle
3.DXX.016.D.1N	160 mm ³ /cycle	3.DXX.016.S.1N	320 mm ³ /cycle
3.DXX.025.D.1N	250 mm ³ /cycle	3.DXX.025.S.1N	500 mm ³ /cycle
3.DXX.040.D.1N	400 mm ³ /cycle	3.DXX.040.S.1N	800 mm ³ /cycle
3.DXX.050.D.1N	500 mm ³ /cycle	3.DXX.050.S.1N	1000 mm ³ /cycle
3.DXX.065.D.1N	650 mm ³ /cycle	3.DXX.065.S.1N	1300 mm ³ /cycle

With visual pin indicator



double outlet

single outlet

Code	Output	Code	Output
3.DXX.008.D.2V	80 mm ³ /cycle	3.DXX.008.S.2V	160 mm ³ /cycle
3.DXX.016.D.2V	160 mm ³ /cycle	3.DXX.016.S.2V	320 mm ³ /cycle
3.DXX.025.D.2V	250 mm ³ /cycle	3.DXX.025.S.2V	500 mm ³ /cycle
3.DXX.040.D.2V	400 mm ³ /cycle	3.DXX.040.S.2V	800 mm ³ /cycle
3.DXX.050.D.2V	500 mm ³ /cycle	3.DXX.050.S.2V	1000 mm ³ /cycle
3.DXX.065.D.2V	650 mm ³ /cycle	3.DXX.065.S.2V	1300 mm ³ /cycle

With inductive sensor M8



double outlet

single outlet

Code	Output	Code	Output
3.DXX.008.D.3I.8	80 mm ³ /cycle	3.DXX.008.S.3I.8	160 mm ³ /cycle
3.DXX.016.D.3I.8	160 mm ³ /cycle	3.DXX.016.S.3I.8	320 mm ³ /cycle
3.DXX.025.D.3I.8	250 mm ³ /cycle	3.DXX.025.S.3I.8	500 mm ³ /cycle
3.DXX.040.D.3I.8	400 mm ³ /cycle	3.DXX.040.S.3I.8	800 mm ³ /cycle
3.DXX.050.D.3I.8	500 mm ³ /cycle	3.DXX.050.S.3I.8	1000 mm ³ /cycle
3.DXX.065.D.3I.8	650 mm ³ /cycle	3.DXX.065.S.3I.8	1300 mm ³ /cycle

With inductive sensor M12



double outlet

single outlet

Code	Output	Code	Output
3.DXX.008.D.3I.12	80 mm ³ /cycle	3.DXX.008.S.3I.12	160 mm ³ /cycle
3.DXX.016.D.3I.12	160 mm ³ /cycle	3.DXX.016.S.3I.12	320 mm ³ /cycle
3.DXX.025.D.3I.12	250 mm ³ /cycle	3.DXX.025.S.3I.12	500 mm ³ /cycle
3.DXX.040.D.3I.12	400 mm ³ /cycle	3.DXX.040.S.3I.12	800 mm ³ /cycle
3.DXX.050.D.3I.12	500 mm ³ /cycle	3.DXX.050.S.3I.12	1000 mm ³ /cycle
3.DXX.065.D.3I.12	650 mm ³ /cycle	3.DXX.065.S.3I.12	1300 mm ³ /cycle

Visual pin

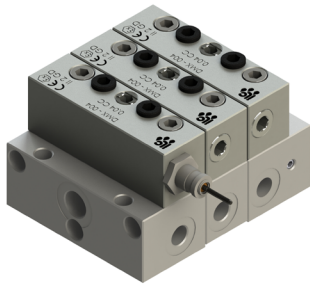

The visual pin shows the piston movement, monitoring the proper operation of the entire system.

Inductive control

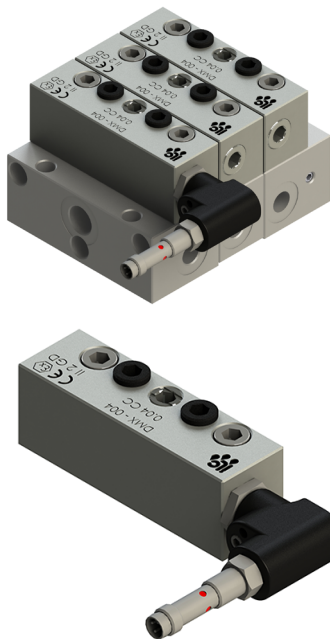

In this control a proximity switch is housed in a composite block.

The piston opens and closes the contact as it moves into its operational seat.

They are usually used in cycle control systems where they can count up to 300 movement for minute.

Electrical Data

Voltage	6-30 V DC
Outlet current	Max 200 mA
Current	< 22 mA
Operating temperature	from - 25 °C to +70 °C
Protection	IP 67
Sensor housing	Stainless steel
Sensor block	Pet-G
Connection	M8x1 - M12x1

Connection cable codes

Length	M8x1 Straight	M12x1 90°	M12x1 Straight
5 m	A91.111227	A91.111316	A91.111349
10 m	A91.111348	A91.111317	A91.111296
15 m	A91.111393	A91.111318	A91.111350

Sensor kit codes

M8x1	49.053.1
M12x1	49.053.2

Electrical connection

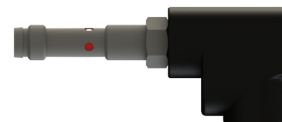
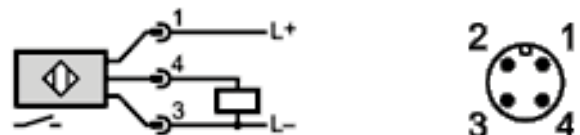

Group II Category 1D-1G/2G

Electrical data

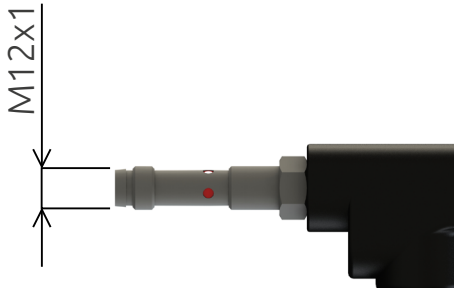

Electrical Model	Certified intrinsically safe circuits with maximum values $U = 15 \text{ V} / I = 50 \text{ mA} / P = 120 \text{ mW}$
Nominal voltage	8,2 DC; (1k Ω)
Voltage	V 7,5...30 DC; to be used outside potentially explosive areas
Current	< 1 blocker; (> 2,1 mA conductore)
Contact	NC
Current capacity [MA]	< 30; to be used outside potentially explosive areas
Temperature	-20...70
Protection	IP 67

Ordering codes

Electrical connection

Inductive control	49.053.2.ATX.1GD
Connection cable (2 m)	

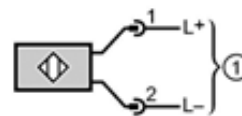

Group II Category 3G-3D

Electrical data

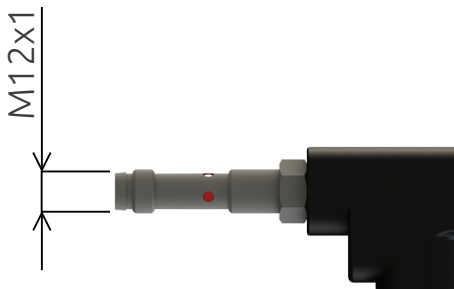

Electrical Model	DC PNP
Nominal voltage	10-36 V DC
Outlet current	MAX 200 mA
Current	< 20 Ma
Temperature	da - 40 °C a + 70 °C
Protection	IP 67
Sensor housing	Stainless steel
Contact	NO

Ordering codes

Electrical connection

Inductive control	49.053.2.ATX
Connection cable (2 m)	

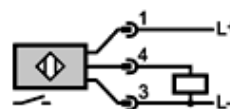

Bridge element

3.DMX.004...065.D.1R/1L/1LR

The bridge element transfers the output of one or both the outlets to the next element. It can be ordered with a left, right or two bridging outlets.

Arrows point which outlets are connected to the next element. They are mounted and replaced as a standard metering valve.

It is important to shut the base outlet corresponding to the arrows on top of the element.

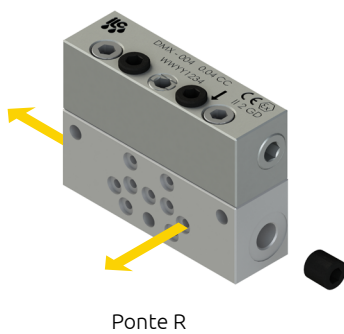
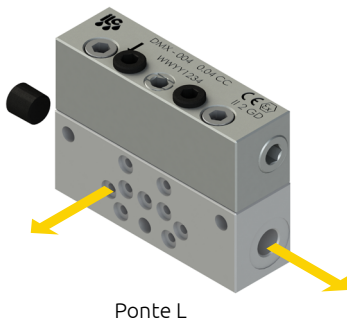
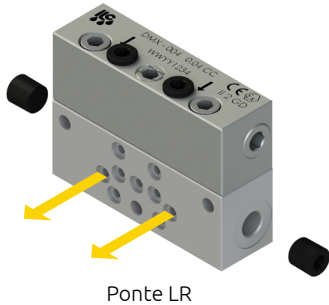

Ordering codes Zi-Ni

40 mm ³ /cycle	3.DMX.004.D.1LR	3.DMX.004.D.1R	3.DMX.004.D.1L
80 mm ³ /cycle	3.DMX.008.D.1LR	3.DMX.008.D.1R	3.DMX.008.D.1L
160 mm ³ /cycle	3.DMX.016.D.1LR	3.DMX.016.D.1R	3.DMX.016.D.1L
250 mm ³ /cycle	3.DMX.025.D.1LR	3.DMX.025.D.1R	3.DMX.025.D.1L
400 mm ³ /cycle	3.DMX.040.D.1LR	3.DMX.040.D.1R	3.DMX.040.D.1L
500 mm ³ /cycle	3.DMX.050.D.1LR	3.DMX.050.D.1R	3.DMX.050.D.1L
650 mm ³ /cycle	3.DMX.065.D.1LR	3.DMX.065.D.1R	3.DMX.065.D.1L

Ordering codes SS316L

40 mm ³ /cycle	3.DXX.004.D.1LR	3.DXX.004.D.1R	3.DXX.004.D.1L
80 mm ³ /cycle	3.DXX.008.D.1LR	3.DXX.008.D.1R	3.DXX.008.D.1L
160 mm ³ /cycle	3.DXX.016.D.1LR	3.DXX.016.D.1R	3.DXX.016.D.1L
250 mm ³ /cycle	3.DXX.025.D.1LR	3.DXX.025.D.1R	3.DXX.025.D.1L
400 mm ³ /cycle	3.DXX.040.D.1LR	3.DXX.040.D.1R	3.DXX.040.D.1L
500 mm ³ /cycle	3.DXX.050.D.1LR	3.DXX.050.D.1R	3.DXX.050.D.1L
650 mm ³ /cycle	3.DXX.065.D.1LR	3.DXX.065.D.1R	3.DXX.065.D.1L

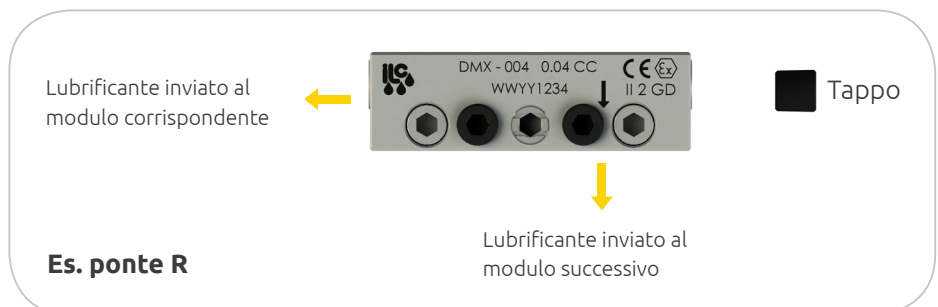

By-pass element

3.DMX.BP



The by-pass element is dimensionally identical to the metering model, but does not contain the piston. It has the function of creating a reserve position when the number of outlets change.

When installed, the outlet holes in the respective-base must be closed.

It can be mounted in advance as a placeholder for additional element or to decrease the outlets number.

At least 3 metering elements are required in order to install a by-pass element.

Ordering codes

Code	Model
3.DMX.BP	Zi-Ni
3.DXX.BP	Acciaio SS316L

Pressure pin indicator (with memory)

09.710.2...7

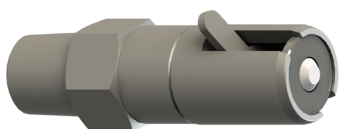
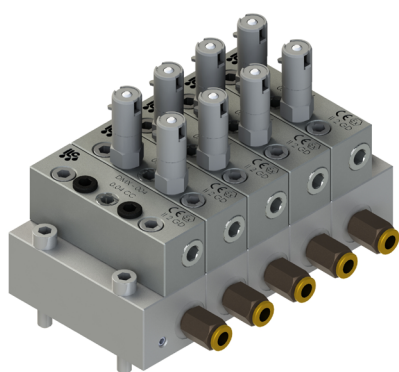

These indicator are usually for overpressure control on primary and secondary lines.

In the eventuality of a pressure higher then expected, the pin indicator moves out. It remains in position until the release lever is manually actuated.

We suggest to discover the reason and the location of the fault before actuating the lever.

Ordering codes

Code	Pressure	Code	Pressure
09.710.2	50 Bar	09.710.5	150 Bar
09.710.3	75 Bar	09.710.6	200 Bar
09.710.4	100 Bar	09.710.7	250 Bar

DIN 2353 Fittings Straight

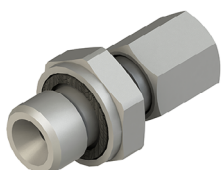

Inlet connections		Outlet connections	
Code	Ø Tube	Code	Ø Tube
TW.100514	6 mm	TW.100501	4 mm
TW.100505	8 mm	TW.100504	6 mm
TW.100506	10 mm	TW.100525	8 mm
		TW.100528	10 mm
Pressure	Thread	Pressure	Thread
500 bar	1/4 BSP CIL	500 bar	1/8 BSP CIL

DIN 2353 Fittings 90°

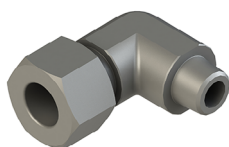

Code	Ø Tube	Code	Ø Tube
TW.102014	6 mm	TW.102001	4 mm
TW.102005	8 mm	TW.102004	6 mm
TW.102006	10 mm	TW.102025	8 mm
		TW.102028	10 mm
Pressure	Thread	Pressure	Thread
500 bar	1/4 BSP K	500 bar	1/8 BSP K

PUSH-IN Fittings Straight

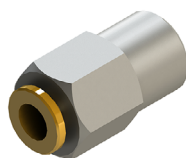

Code	Ø Tube	Code	Ø Tube
03.257.4	6 mm	03.255.0	4 mm
		03.256.0	6 mm
Pressure	Thread	Pressure	Thread
250 bar	1/4 BSP K	250 bar	1/8 BSP K

PUSH-IN Fittings 90°



Code	Ø Tube	Code	Ø Tube
03.257.2	6 mm	03.255.0	4 mm
		03.256.0	6 mm
Pressure	Thread	Pressure	Thread
250 bar	1/4 BSP K	250 bar	1/8 BSP K

Check Valve



Code	Thread	Code	Thread
14.060.3	1/4 - 1/4 BSP MF	14.060.4	1/8 BSP -1/4 BSP MF
		14.051.4	1/8 BSP -1/8 BSP

Metering block assembly order

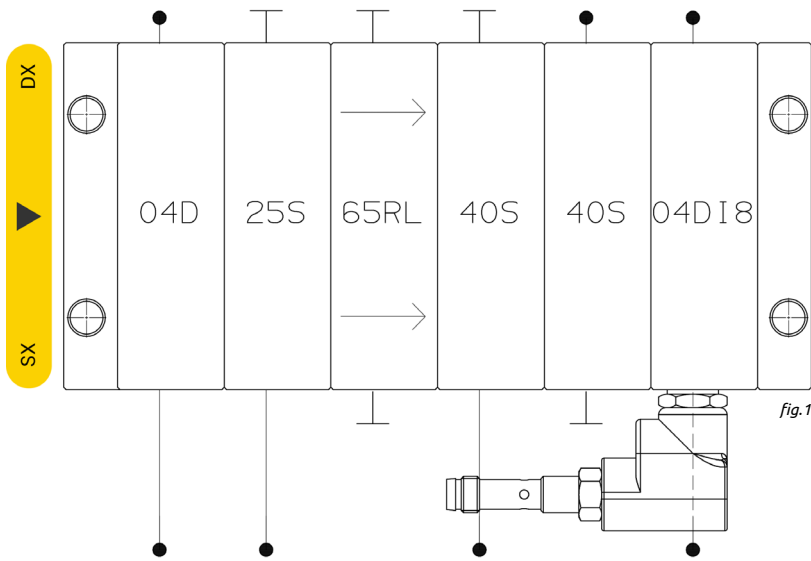

To place an Assembled block order, follow the scheme shown in the tables aside.

the code composition creates a string. The string identifies the assembly exact number of element, outputs and outlets, and the presence of control elements.

Start placing the element number related code, choosing from table (A). To place a five element assembly order we would write

06

Select the code of every and each element desired from the first one, where the lubricant inlet is, to the last one.

A number identifies the output (table B) and a letter identifies the model (table C). E.G.

04D - 25S - 65RL - 40S - 40S

If a control monitoring element is required, insert the the desired model (table D) after the valve code E.G.

04D - 25S - 65RL - 40S - 40S - 04DI8

The resulting sample assembly string would appear like this

06 - 04D - 25S - 65RL - 40S - 40S - 04DI8

Then this code will be converted in a **Ordering Code**.

A (Elements)

N°	Type	N°	Type
3	03	12	12
4	04	13	13
5	05	14	14
6	06	15	15
7	07	16	16
8	08	17	17
9	09	18	18
10	10	19	19
11	11	20	20

B (Output)

Ouput (mm³)	Type
40	04
80	08
160	16
250	25
400	40
500	50
650	65
by-pass	00

C (Model)

Element model	Type
two outlets	D
one outlet	S
Bridge right outlet	1R
Bridge left outlet	1L
Bridge L/R outlet	1LR

D (Control)

Control Element	Sigla
Visual pin indicator	V
Inductive sensor M8	I8
Inductive sensor M12	I12
Ind. Sens. ATEX 1D-1G/2G	IATX2
Ind. Sens. ATEX 3G/3D	IATX3

DMX-A

The DMX-A model is designed to send a flow of air/oil to specific lubrication points.

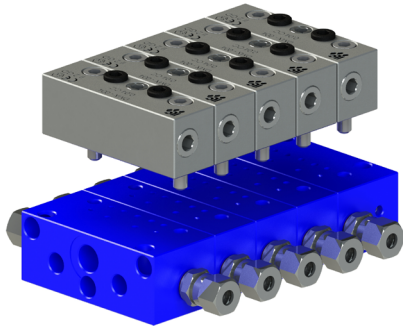

Lubricant economy

The oil delivered into air stream is accurately metered. This avoids expensive lubricant waste.

Lubricant viscosity

DMX-A uses any type of lubricant with viscosity between 15 e 1000 cSt at a fluids working temperature between 0°C e 80°C .

The best conditions are obtained with oil viscosity between 32 e 320 cSt at a temperature 40°C.

Cooling and retaining action

The continuous supply of a mixed air stream, besides lubricating, it has also a cooling effect. The over-pressure inside the lubricated element, prevents the ingress of foreign bodies. prevent the access of foreign body.

The air-oil system does not produce oil mist and therefore does not produce fogging. The constant air flux helps lubricant advancement along the internal walls. When the lubricant reaches the final point is spread in particles.

Functioning control

Thanks to the progressive system, the malfunctioning of a metering element is reported by a control device.

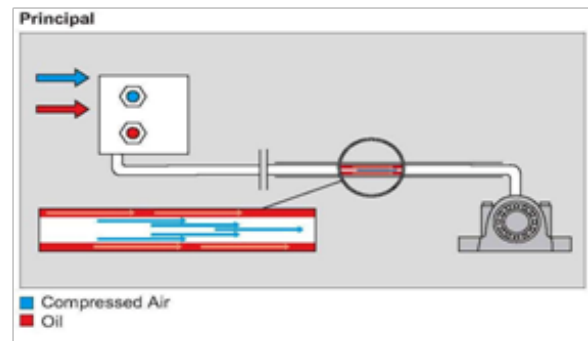

Application fields

- Lubrication of high speed rotating elements. Due to high centrifuge power, the lubricating film between the elements is carried off, so a constant distribution of small quantities of lubricant is required.
- Lubrication of machinery parts working at high temperatures where the lubricant tends to be dried or burned.
- Spray lubrication of chains or gears.
- Lubrication of slides and ways which require a thin film of lubricant all over their surface.
- Lubrication of bearings which need protection for dust infiltration, water or other damaging substances. The mixed air flow creates a slight over pressure inside the lubricated element, preventing the intrusion of other polluted bodies
- Lubrication of point which cannot be reached by traditional lubrication system, where only an oil spray can solve the problem

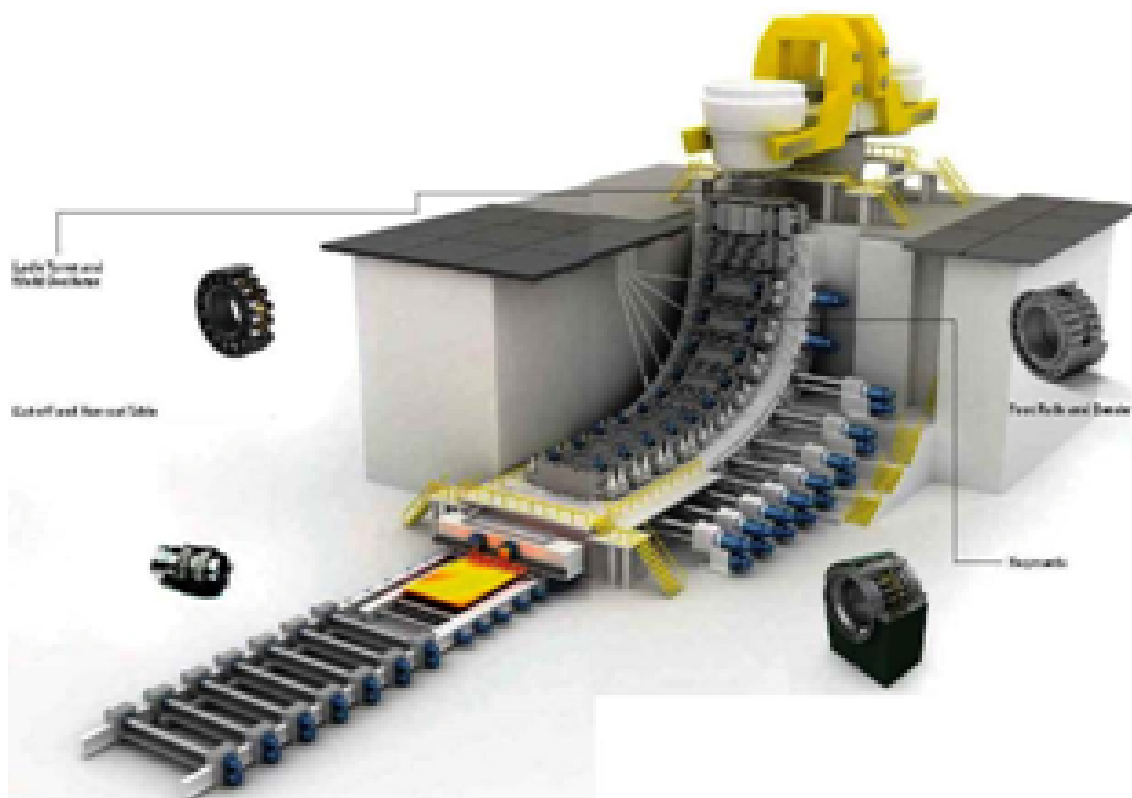

Single bases

3.DMX.A.A/B.A/C.A

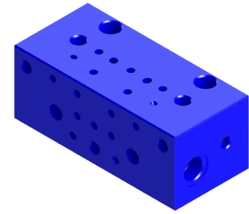
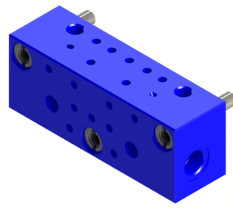
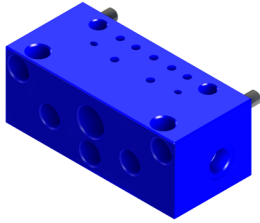

Code	3.DMX.A.A	Code	3.DMX.B.A	Code	3.DMX.C.A
Description	Initial base	Description	Intermediate base	Description	Final base

Assembly

3.DMX.A.03...20

Code	Assembled bases
3.DMX.A.03	3
3.DMX.A.04	4
3.DMX.A.05	5
3.DMX.A.06	6
3.DMX.A.07	7
3.DMX.A.08	8
3.DMX.A.09	9
3.DMX.A.10	10

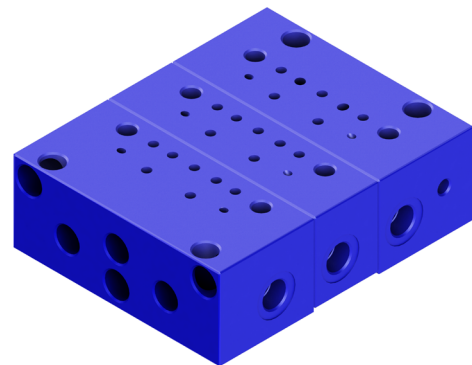

3.DMX.A.03

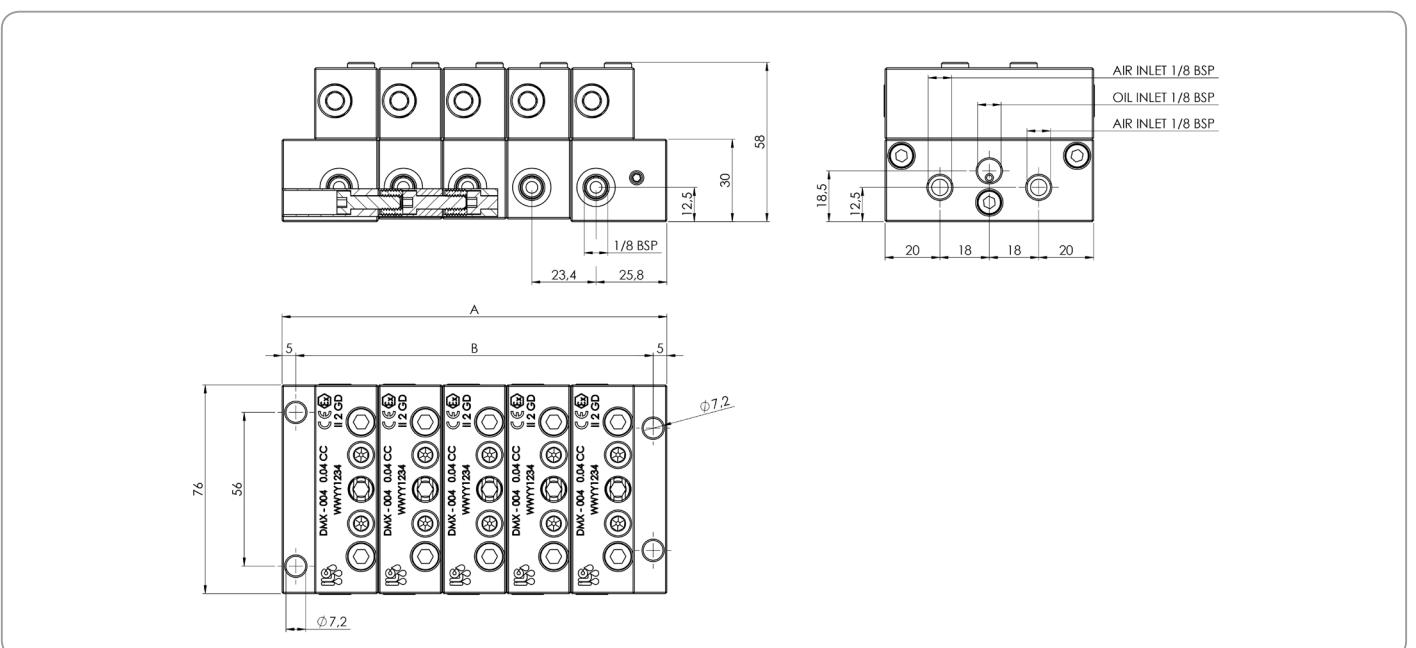

Connections

In addition to the lubricant inlet configuration the DMX-A has two inlets for the air supply. All the threads are 1/8 BSP.

The two pneumatic lines respectively supply the right and left side outlets of the distributor. The supply of both is not required.

As shown in the picture below, the operating pressure in the lubricant line must not exceed 100 bar.

It is important to order specific outlet fittings both for a mixed output and an oil one. The two fitting models are supplied with a check valve to separate the two flows up the pipe and to prevent any backflow of lubricant in the pneumatic line.

Outlet fittings



Outlet air-oil mixing fittings

Model	Ø Tube	Code
Air-oil outlet	6 mm	A70.093679
Oil outlet	6 mm	A70.093680

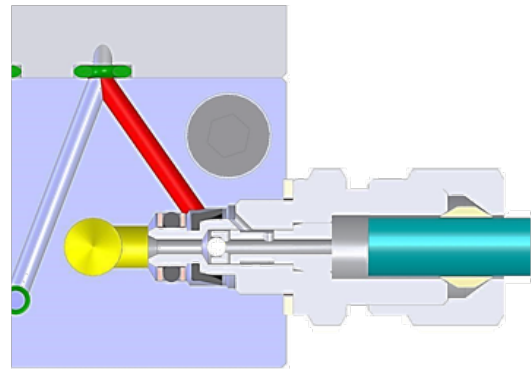
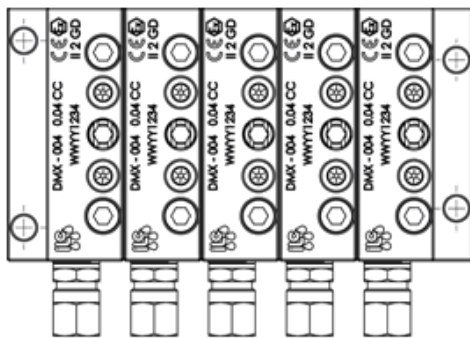

DMX element air consumption

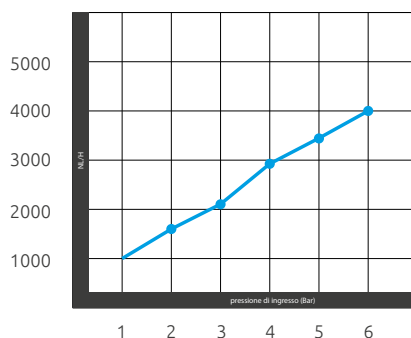

The Normal liter/hour air consumption depends on applied pressure, users number and point connection tube diameter (be careful in case of spray, nozzle diameter must be kept into account).

The maximum lubricant-line working pressure must not exceed 100 bar.

Shut-off Valves

Ordering codes

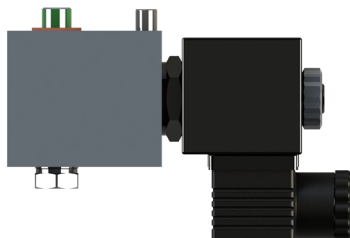

In **air-oil** systems the single or grouped metering valves selection is even more important.

In some common application field as for Siderurgical Facilities, EV-2 valves are required due to circuit length or the needing for system section exclusion.

Ordering codes

Code	Voltage
A70.093688	24 V DC
A70.093688.115	115 V AC
A70.093688.230	230 V AC

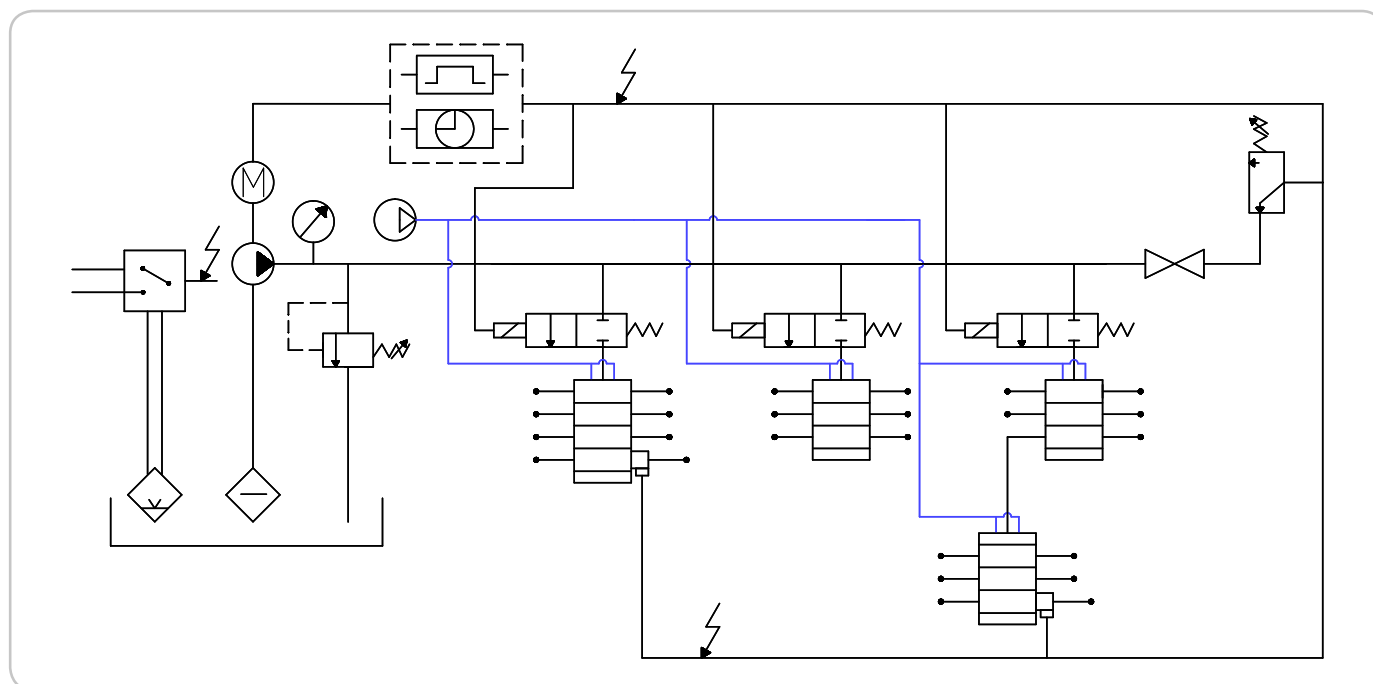

Metering block assembly order

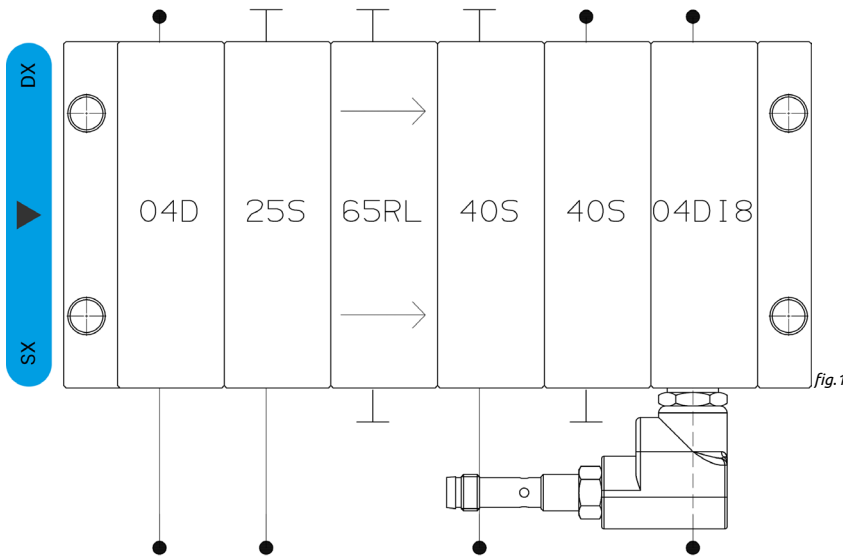

To place an Assembled block order, follow the scheme shown in the tables aside.

the code composition creates a string. The string identifies the assembly exact number of element, outputs and outlets, and the presence of control elements.

Start placing the element number related code, choosing from table (A). To place a five element assembly order we would write

06A

Select the code of every and each element desired from the first one, where the lubricant inlet is, to the last one.

A number identifies the output (table B) and a letter identifies the model (table C). E.G.

04D - 25S - 65RL - 40S - 40S

If a control monitoring element is required, insert the the desired model (table D) after the valve code E.G.

04D - 25S - 65RL - 40S - 40S - 04DI8

The resulting sample assembly string would appear like this

06A - 04D - 25S - 65RL - 40S - 40S - 04DI8

Then this code will be followed by an **Ordering Code**.

A (Elementi)

N°	Type
3	03A
4	04A
5	05A
6	06A
7	07A
8	08A
9	09A
10	10A

B (Ouput)

Ouput	Type
0,04	04
0,08	08
0,16	16
0,25	25
0,40	40
0,50	50
0,65	65
by-pass	00

C (Model)

Modello Elemento	Type
Two outlets	D
One outlet	S
Bridge right outlet	PR
Bridge left outlet	RL
Bridge L/R outlet	PRL

D (Control)

Control Element	Sigla
Visual pin indicator	V
Inductive sensor M8	I8
Inductive sensor M12	I12
Ind. Sens. ATEX 1D-1G/2G	IATX2
Ind. Sens. ATEX 3G/3D	IATX3

I.L.C. srl - Via Garibaldi, 149 - 20155 Gorla Minore - Italy
Phone +39 0331 601697 - Fax +39 0331 602001 - www.ilclube.com - info@ilclube.it

